

ENERGIZER 3-315

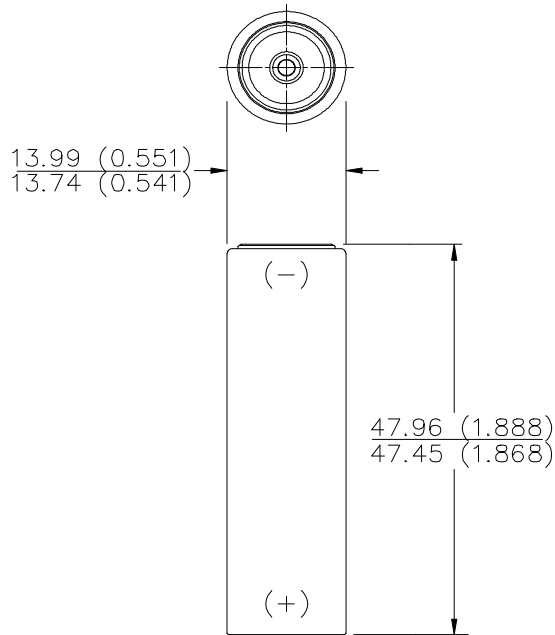

Typical Dimensions

mm (inches)



- Chemical System:** Alkaline
Zinc-Manganese Dioxide (Zn/MnO₂)
(No Added Mercury or Cadmium)
- Battery Voltage:** 1.5 Volts
- Internal Resistance:** 146 Milliohms (Fresh)
- Operating Temp:** -18°C to 55°C (0°F to 130°F)
- Average Capacity:** 2,850 mAh (to 0.8 volts)
(Rated capacity at 25 mA continuous drain)
- Average Weight:** 22.4 grams (0.8 oz.)
- Volume:** 7.4 cubic centimeters (0.5 cubic inch)
- Cell:** One No. 3-315 (size 'AA')
- Jacket:** None

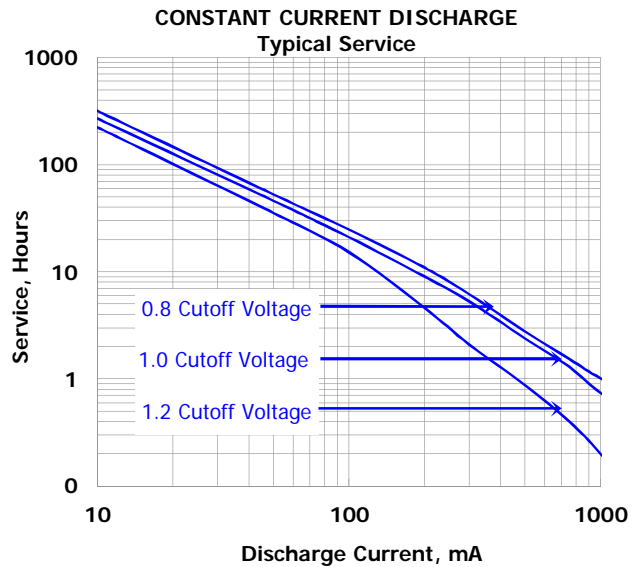
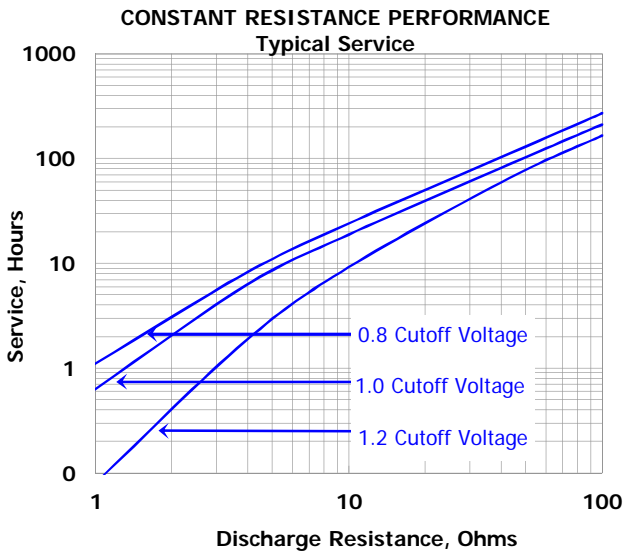
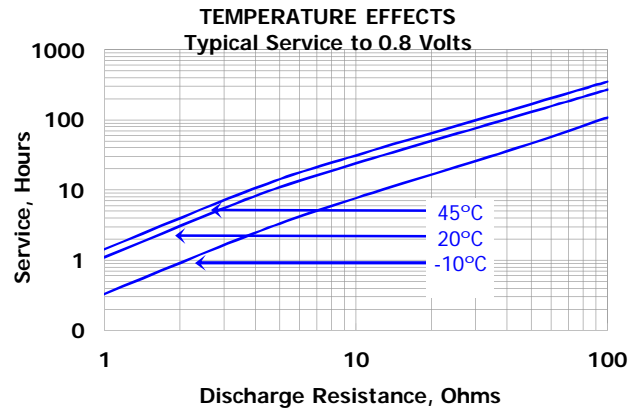

Important Notice

This data sheet contains information specific to batteries manufactured at the time of its publication.
Contents herein do not constitute a warranty.
Copyright © Eveready Battery Co. - All rights reserved

ENERGIZER 3-315

CONSTANT POWER DISCHARGE
Typical Service

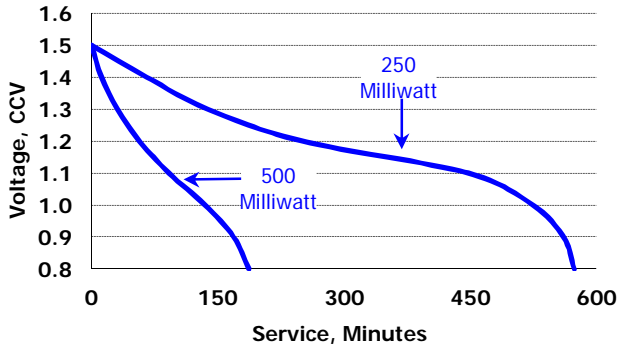

CONSTANT POWER DISCHARGE
Typical Service

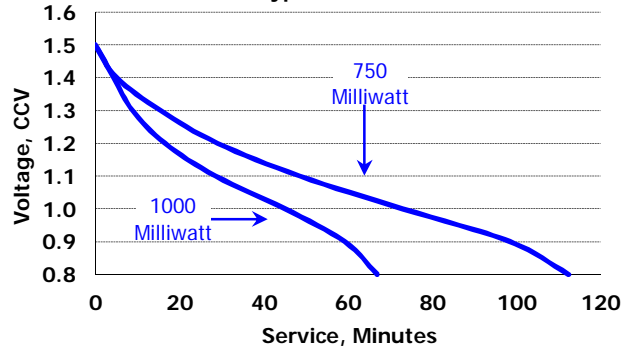

Industry Standard Tests (21° C)

RADIO
43 ohm - 4 hours/day

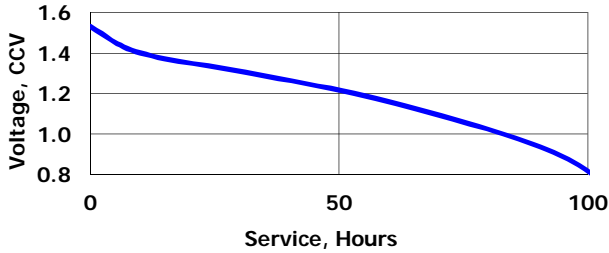

LIGHTING 3.3 ohm - LIF TOY 3.9 ohm - 1 hr/day

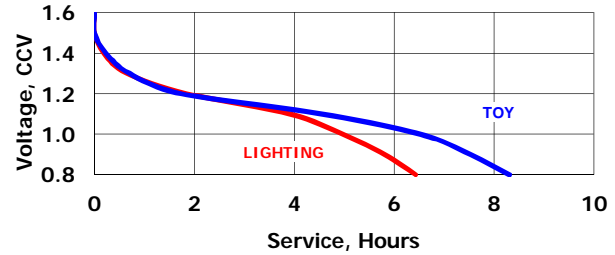

REMOTE
24 ohm - 15 spm - 8 hr/day

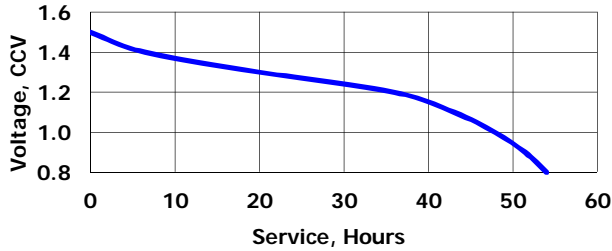

TAPE PLAYER
100 mA - 1 hr/day

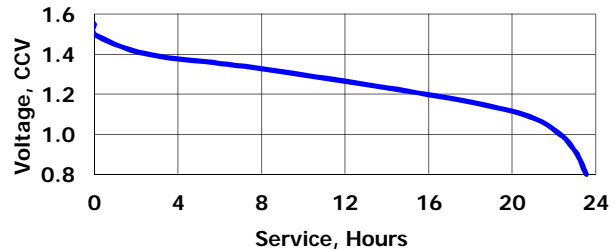

CD / MD / ELEC GAME
250 mA - 1 hr/day

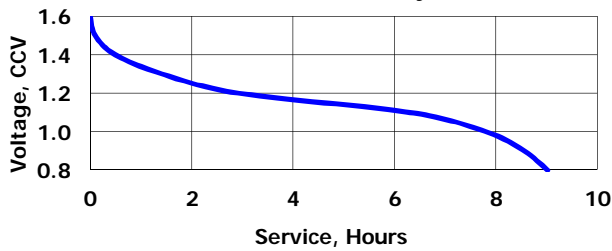

DIGITAL CAMERA 1.5/6.5K mW 2/28s 10X/hr PHOTO 1000 mA 10 sec/min 1 hr/day

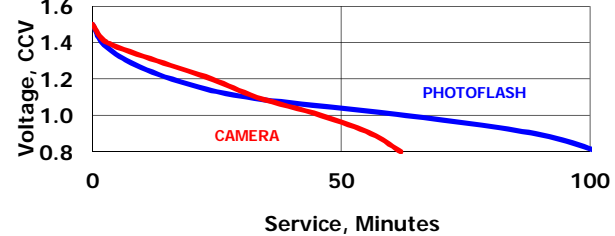

Important Notice

This data sheet contains information specific to batteries manufactured at the time of its publication.

Contents herein do not constitute a warranty.

Copyright © Eveready Battery Co. - All rights reserved