

ENERGIZER 319

SILVER OXIDE

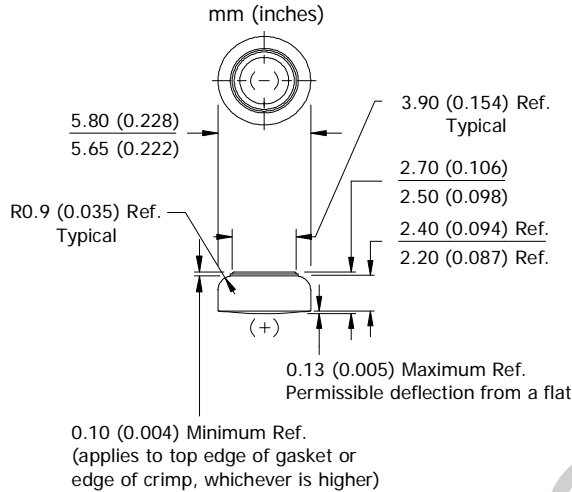

Industry Standard Dimensions



Specifications

- Chemical System:** Silver Oxide (Zn/Ag<sub>2</sub>O)
- Nominal Voltage:** 1.55 Volts
- Typical Capacity:** 19 mAh\* (to 1.2 volts)
- Capacity Test:** 68K ohm continuous drain at 21°C
- Typical Weight:** 0.31 grams (0.011 oz.)
- Typical Volume:** 0.07 cubic centimeters (0.004 cubic inch)
- Impedance (40 Hz):** 50 to 60 ohms

\* Varies according to the applied load, temperature, and cutoff voltage.

Cross Section

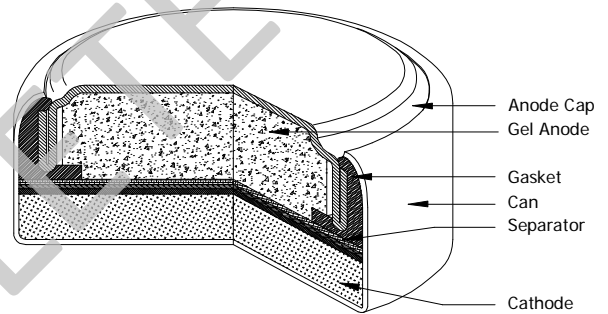

DESIGNED FOR USE ON CONTINUOUS LOW DRAIN

Typical Discharge Characteristics

Typical Performance at 21°C (70°F)

Schedule: Continuous  
Typical Drain @1.55V:  
0.023 milliamperes  
Load: 68K ohm

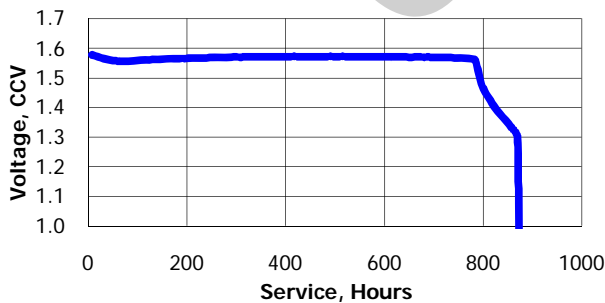

Schedule	Typical Drains at 1.55V (milliamperes)	Load (ohm)	Cutoff (hours)
Continuous	0.023	68K	835

Temperature Characteristics

Typical Performance at Low Discharge Rates

Service Effects

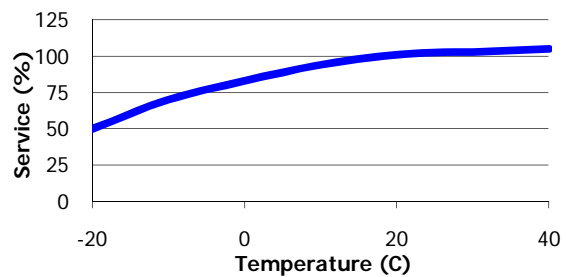

Storage Effects

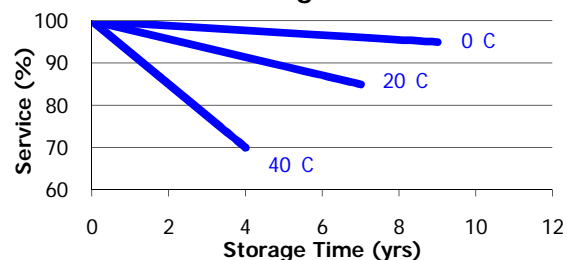

Important Notice

This datasheet contains typical information specific to products manufactured at the time of its publication.  
© Energizer Holdings, Inc. - Contents herein do not constitute a warranty.