

ENERGIZER 329

SILVER OXIDE

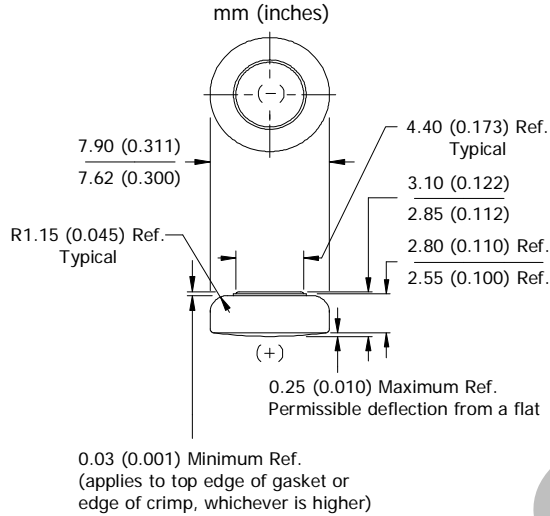

Industry Standard Dimensions



DESIGNED FOR USE ON CONTINUOUS LOW DRAIN

Specifications

- Chemical System:** Silver Oxide (Zn/Ag₂O)
- Nominal Voltage:** 1.55 Volts
- Typical Capacity:** 39 mAh* (to 1.2 volts)
- Capacity Test:** 22K ohm continuous drain at 21°C
- Typical Weight:** 0.58 grams (0.02 oz.)
- Typical Volume:** 0.15 cubic centimeters (0.009 cubic inch)
- Impedance (40 Hz):** 55 to 65 ohms

* Varies according to the applied load, temperature, and cutoff voltage.

Cross Section

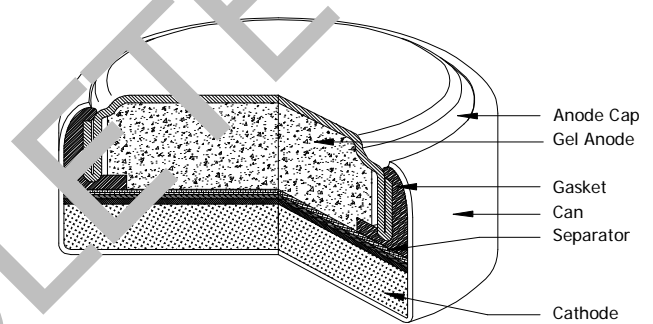

Typical Discharge Characteristics

Typical Performance at 21°C (70°F)

Schedule: Continuous
Typical Drain @ 1.55V:
0.070 milliamperes
Load: 22K ohm

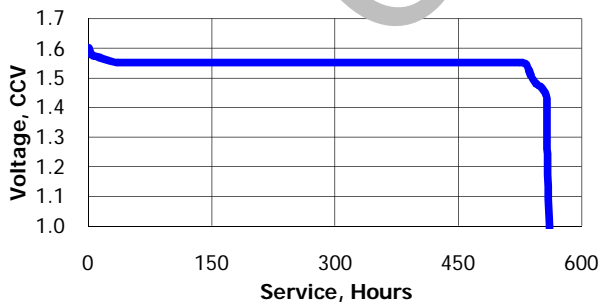

Schedule	Typical Drains at 1.55V (milliamperes)	Load (ohm)	Cutoff (hours)
Continuous	0.070	22K	557

Temperature Characteristics

Typical Performance at Low Discharge Rates

Service Effects

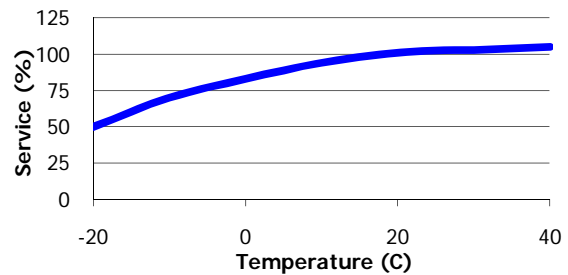

Storage Effects

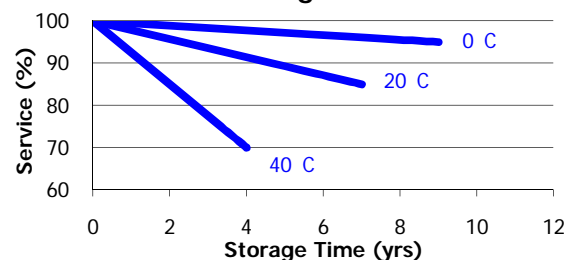

Important Notice

This datasheet contains typical information specific to products manufactured at the time of its publication.
© Energizer Holdings, Inc. - Contents herein do not constitute a warranty.