

ENERGIZER NO. 364

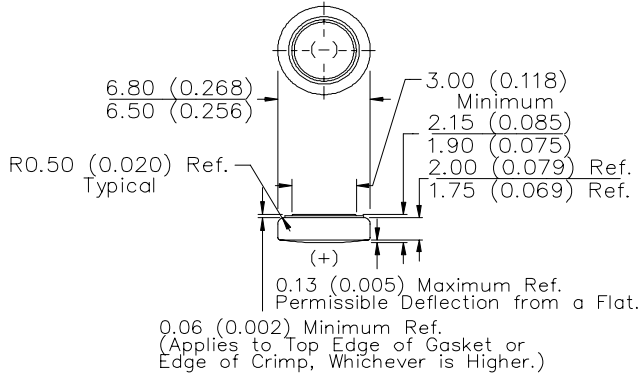

Industry Standard Dimensions in mm (inches)



Chemical System: Silver Oxide (Zn/Ag₂O)

Designation: ANSI / NEDA-1175SO, IEC-SR60
Battery Voltage: 1.55 Volts
Average Weight: 0.31 grams (0.11 oz.)
Volume: 0.08 cubic centimeters (0.005 cubic inch)
Average Capacity: 20 mAh to 1.3 volts
 (Rated at 68k ohms continuous at 21°C)

TYPICAL DISCHARGE CURVE
 Simulated Test @ 21°C (70°F)

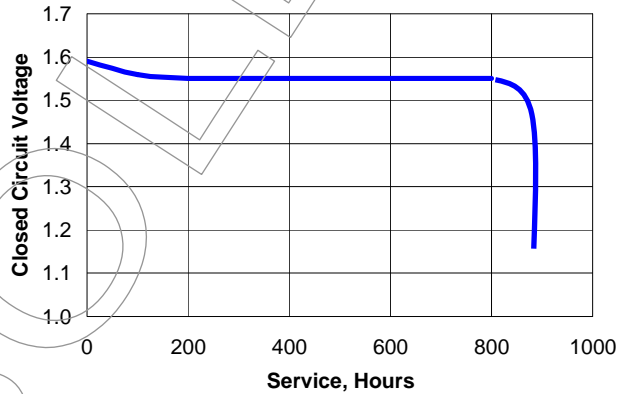

DESIGNED FOR USE ON CONTINUOUS LOW DRAIN

Simulated Application Test Estimated Average Service at 21°C (70°F)

Schedule:	Typical Drains at 1.55V (milliamperes)	Load (ohms)	Cutoff Voltage
			1.3V
24 hours/day	0.023	68,000	870 Hours

INTERNAL RESISTANCE: Closed circuit voltage no less than 0.85 volts on a load of 100 ohms at 21°C (70°F) for 0.1 to 2.0 seconds.

Typical closed circuit voltage during discharge on a load of 2,000 ohms for 0.0078 seconds.

Depth of Discharge as Percent of Rated Capacity

Temperature	0%	40%	80%
21°C (70°F)	1.58V	1.55V	1.55V
-10°C (14°F)	1.48V	1.38V	1.38V

Important Notice

This data sheet contains information specific to batteries manufactured at the time of its publication.

Contents herein do not constitute a warranty.

Copyright © Eveready Battery Co. Inc. - All Rights Reserved