

ENERGIZER 394/380

SILVER OXIDE

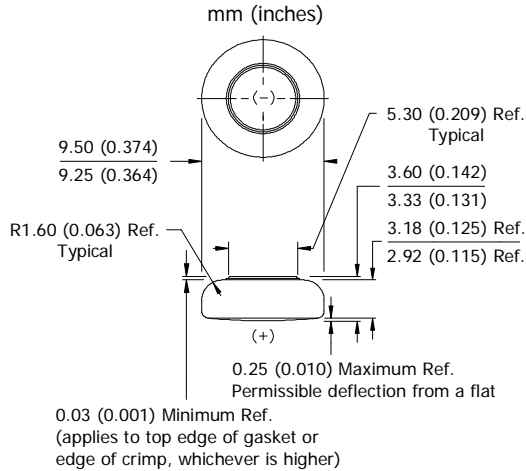

Industry Standard Dimensions



DESIGNED FOR USE ON CONTINUOUS LOW DRAIN
HIGH PULSE ON DEMAND

Specifications

- Chemical System:** Silver Oxide (Zn/Ag₂O)
- Nominal Voltage:** 1.55 Volts
- Typical Capacity:** 63 mAh* (to 1.2 volts)
- Capacity Test:** 15K ohm continuous drain at 21°C
- Typical Weight:** 1.1 grams (0.039 oz.)
- Typical Volume:** 0.25 cubic centimeters (0.015 cubic inch)
- Impedance (40 Hz):** 5 to 15 ohms

* Varies according to the applied load, temperature, and cutoff voltage.

Cross Section

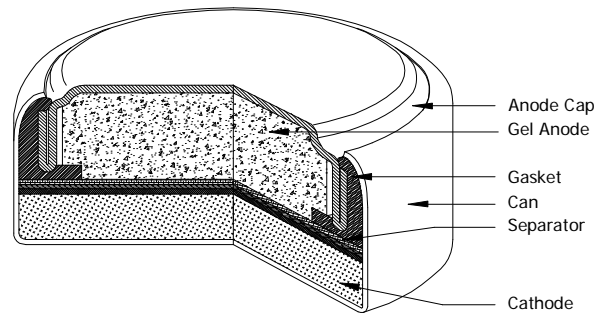

Typical Discharge Characteristics

Typical Performance at 21°C (70°F)

Schedule: Continuous
Typical Drain @ 1.51V:
0.101 milliamperes
Load: 15K ohm

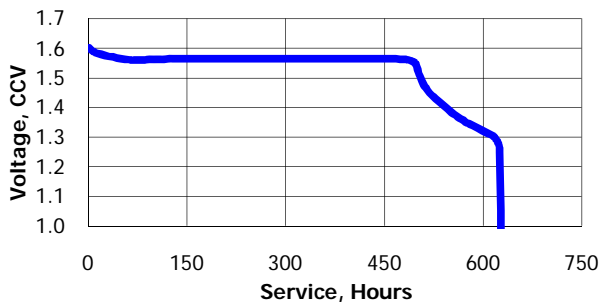

<u>Schedule</u>	<u>Typical Drains</u> at 1.51V (milliamperes)	<u>Load</u> (ohm)	<u>Cutoff</u> 1.2V (hours)
Continuous	0.101	15K	625

Temperature Characteristics

Typical Performance at Low Discharge Rates

Service Effects

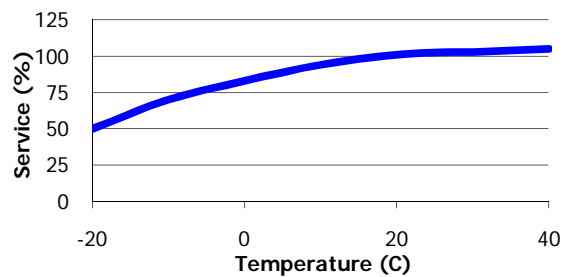

Storage Effects

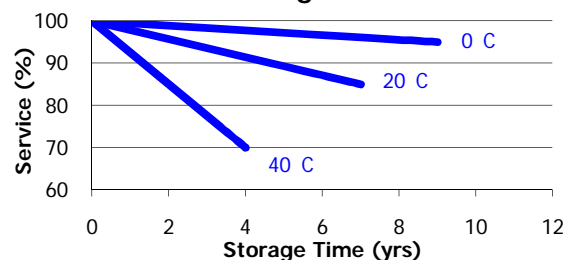

Important Notice

This datasheet contains typical information specific to products manufactured at the time of its publication.
© Energizer Holdings, Inc. - Contents herein do not constitute a warranty.