

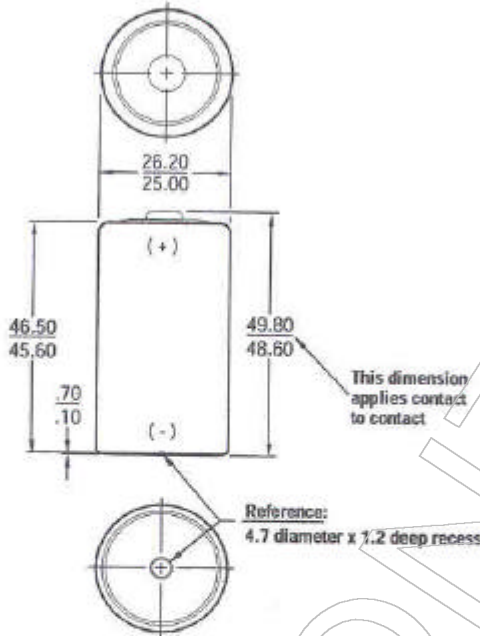

Eveready Battery Company, Inc.
 Checkerboard Square
 St. Louis, MO 63164
 Telephone: 1-800-383-7323
 Internet: www.energizer.com

Engineering Data

EVEREADY NO. 935



C
 Zinc Chloride 1.5V
 Classic
 No Added Mercury or Cadmium

Chemical System: Zinc-Manganese Dioxide (Zn/MnO₂)
Designation: ANSI-14F, IEC-R14
Battery Voltage: 1.5 Volts
Average Weight: 47 grams (1.5 oz.)
Volume: 25 cubic centimeters (1.5 cubic inch)
Average Service Capacity (to 0.8 Volt / cell): 1.8 Ah
 (Rated capacity at 25 mA continuous drain)
Cells: One No. 35 (size "C")
Jacket: Plastic Laminated Paper

Dimensions (mm)

Millimeters	Inches
.10	.004
.70	.028
1.20	.047
4.70	.185
25.00	.984
26.20	1.031
45.60	1.795
46.50	1.831
48.60	1.913
49.80	1.961

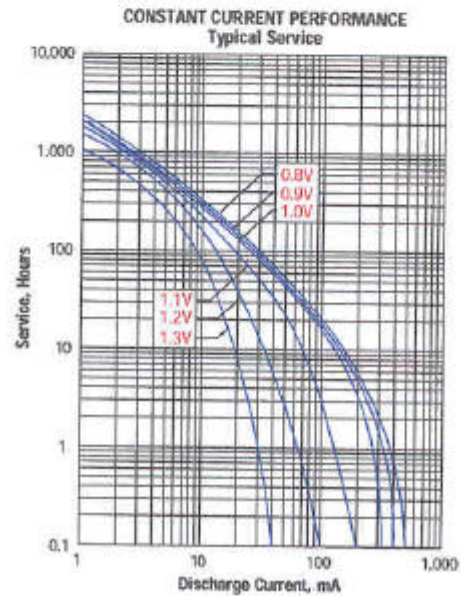
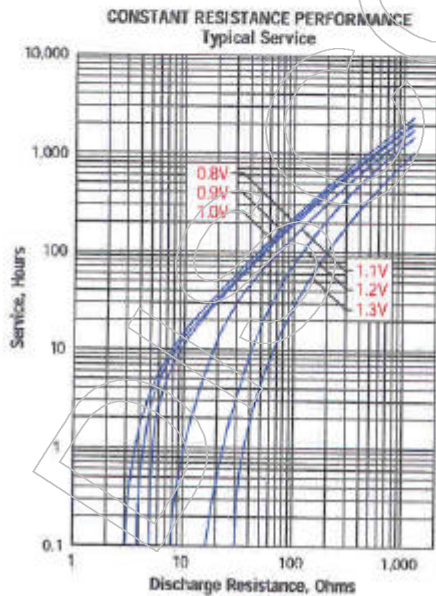

TYPICAL APPLICATIONS

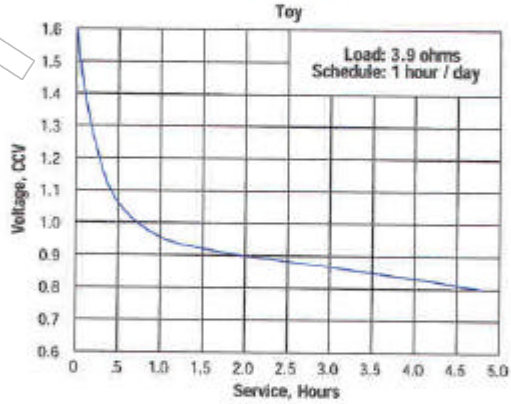
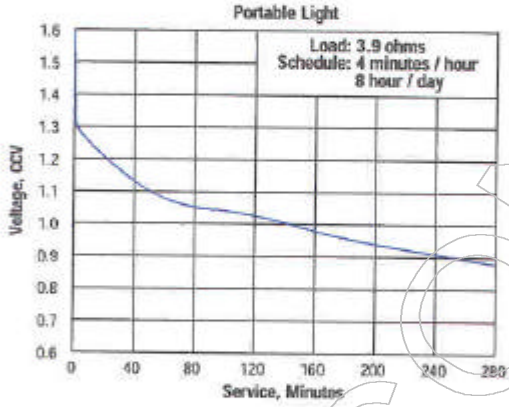
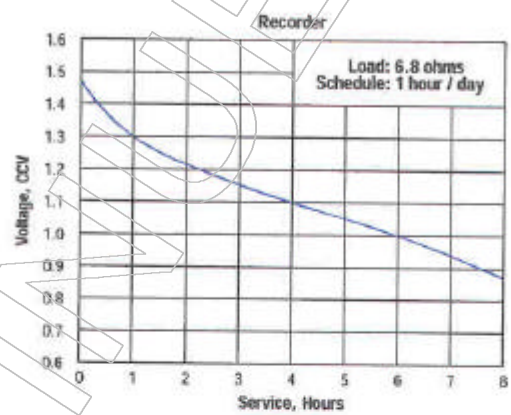
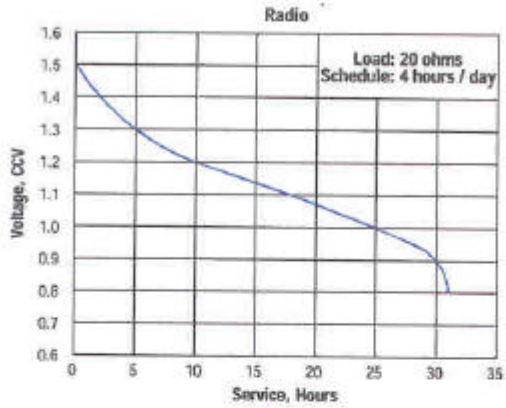

IMPORTANT NOTICE

This data sheet contains information specific to batteries manufactured at time of its publication. Please contact your Energizer representative for most current information. Contents herein do not constitute a warranty.