

ENERGIZER NO. A522V

9V

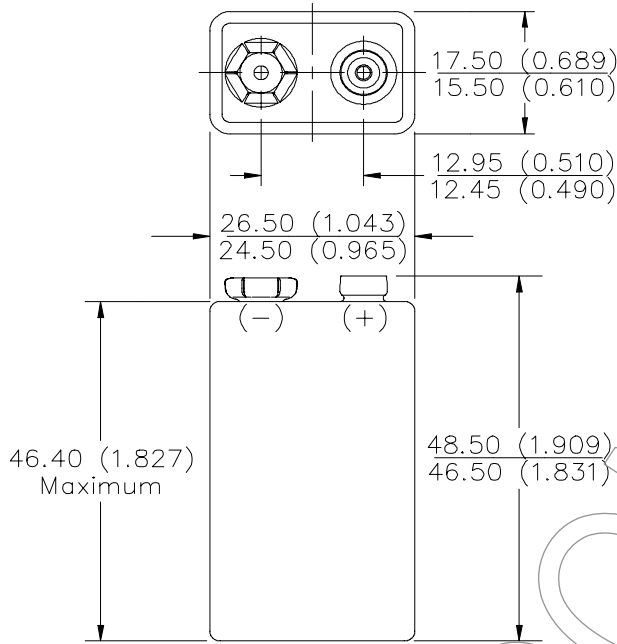

Industry Standard Dimensions in mm (inches)



Chemical System: Alkaline
 Zinc-Manganese Dioxide (Zn/Mn₂)
 (No Added Mercury or Cadmium)

Designation: ANSI-1604A, IEC-6LR61

Battery Voltage: 9.0 Volts

Operating Temp: -18°C to 55°C (0°F to 130°F)

Average Capacity: 565 mAh (to 0.8 volts/cell)
 (Rated capacity at 25 mA continuous drain.)

Average Weight: 45.6 grams (1.6 oz.)

Volume: 21.1 cubic centimeters (1.3 cubic inch)

Cell: Six No. 3-0316 in series

Jacket: Metal

Shelf Life: 5 years (80% of rated capacity)

TEMPERATURE EFFECTS
 Typical Service to 4.8 Volts

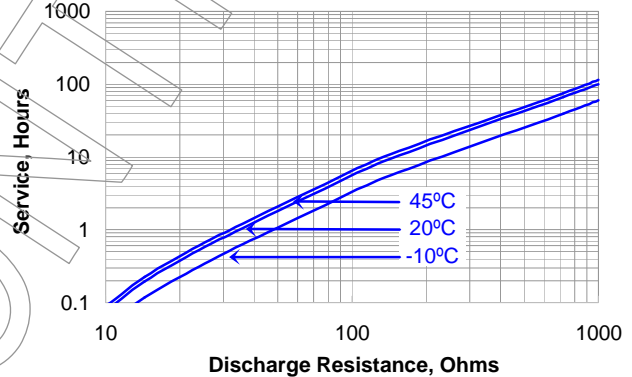

CONSTANT RESISTANCE PERFORMANCE
 Typical Service

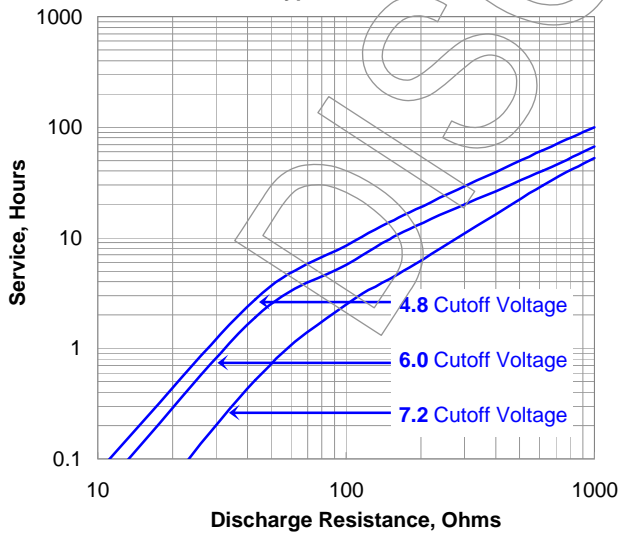

CONSTANT CURRENT DISCHARGE
 Typical Service

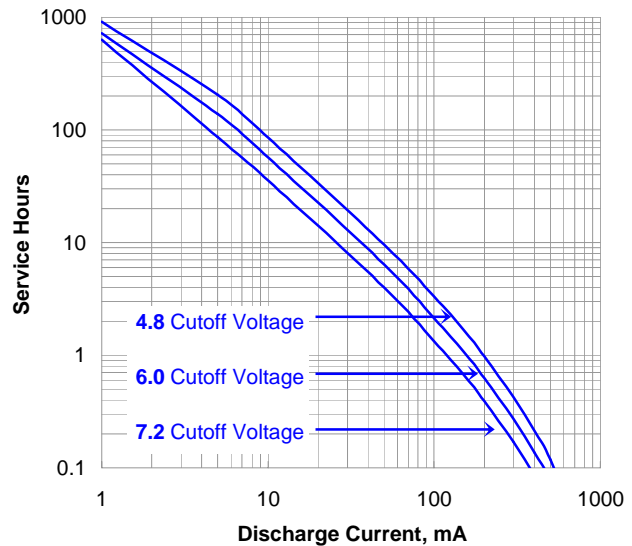

Important Notice

This data sheet contains information specific to batteries manufactured at the time of its publication.

Contents herein do not constitute a warranty.

Copyright © Eveready Battery Co. - All rights reserved

ENERGIZER NO. A522V

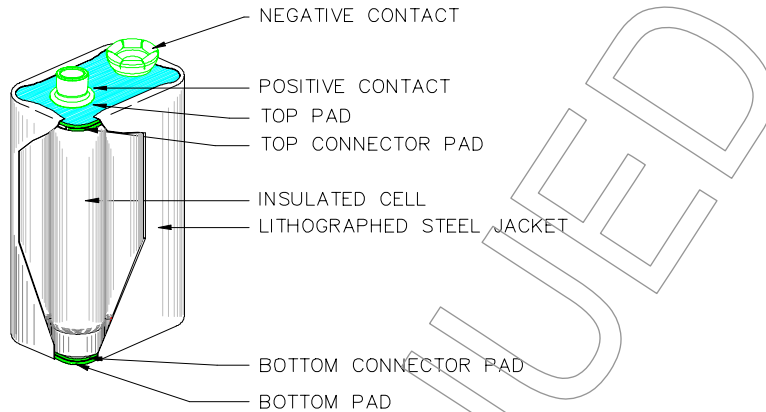

ANSI - IEC Industry Standard Tests @ 20° C

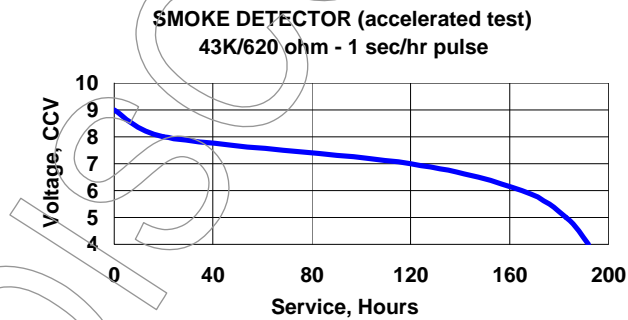
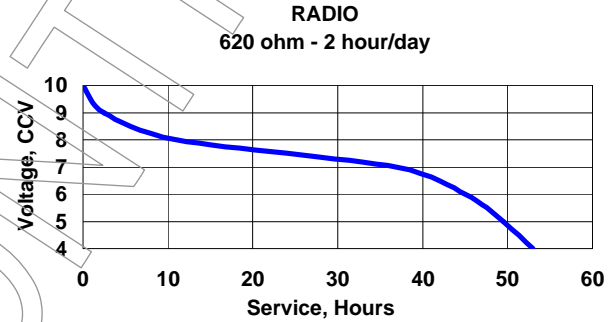
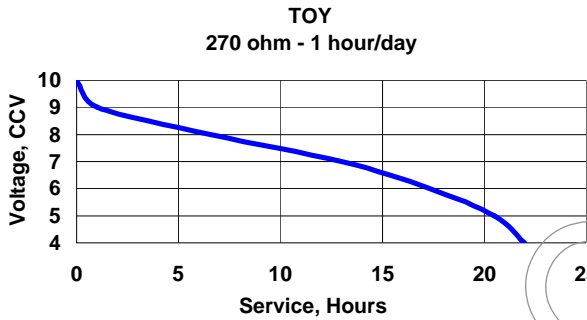

Important Notice

This data sheet contains information specific to batteries manufactured at the time of its publication.

Contents herein do not constitute a warranty.

Copyright © Eveready Battery Co. - All rights reserved