

ENERGIZER NO. A92V

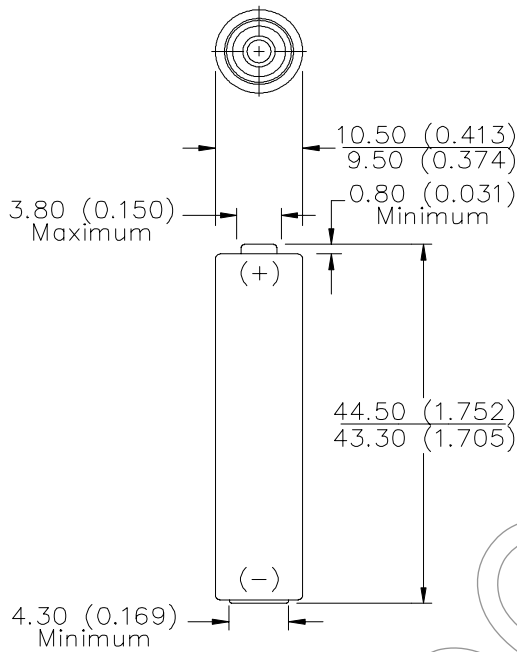

Industry Standard Dimensions in mm (inches)



AAA

Chemical System: Alkaline
 Zinc-Manganese Dioxide (Zn/MnO₂)
 (No Added Mercury or Cadmium)

Designation: ANSI-24A, IEC-LR03

Battery Voltage: 1.5 Volts

Internal Resistance: 205 Milliohms (Fresh)

Operating Temp: -18°C to 55°C (0°F to 130°F)

Average Capacity: 1,200 mAh (to 0.8 volts)
 (Rated capacity at 25 mA continuous drain.)

Average Weight: 11.5 grams (0.4 oz.)

Volume: 3.8 cubic centimeters (0.2 cubic inch)

Cell: One No. 3-312 (size 'AAA')

Jacket: Plastic Label

Shelf Life: 5 years (80% of rated capacity)

TEMPERATURE EFFECTS Typical Service to 0.8 Volts

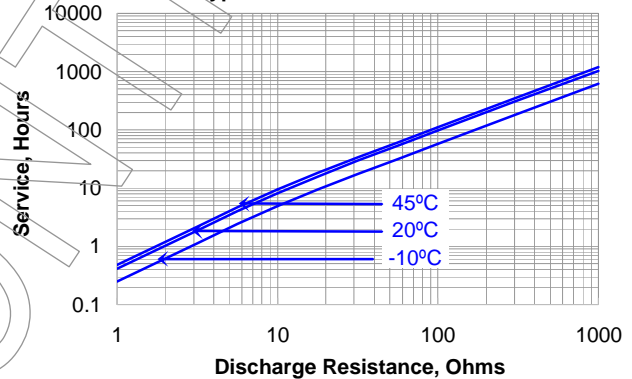

CONSTANT RESISTANCE PERFORMANCE Typical Service

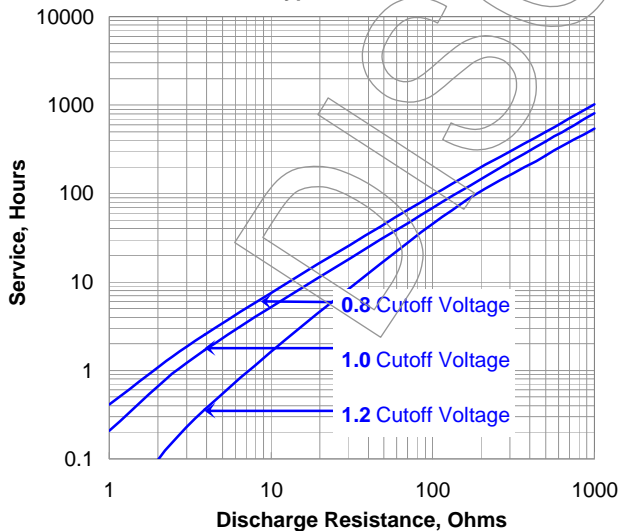

CONSTANT CURRENT DISCHARGE Typical Service

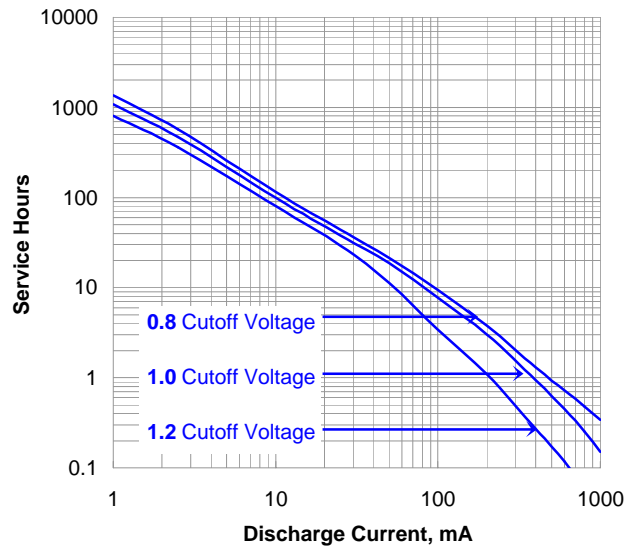

Important Notice

This data sheet contains information specific to batteries manufactured at the time of its publication.

Contents herein do not constitute a warranty.

Copyright © Eveready Battery Co. - All rights reserved

ENERGIZER NO. A92V

ANSI - IEC Industry Standard Tests @ 20° C

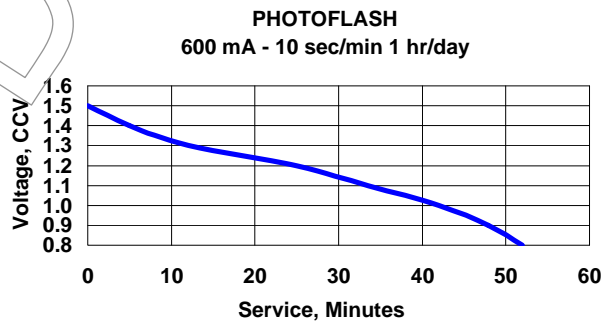
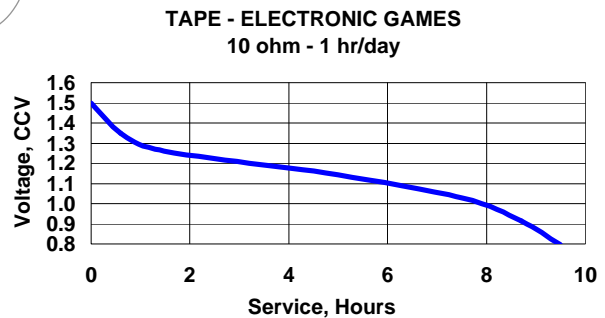
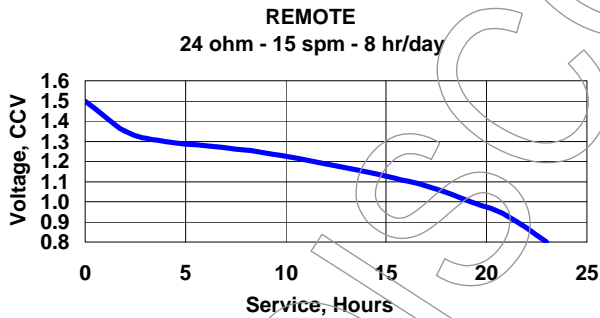
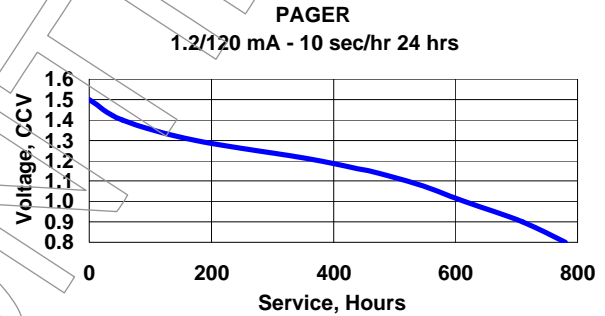
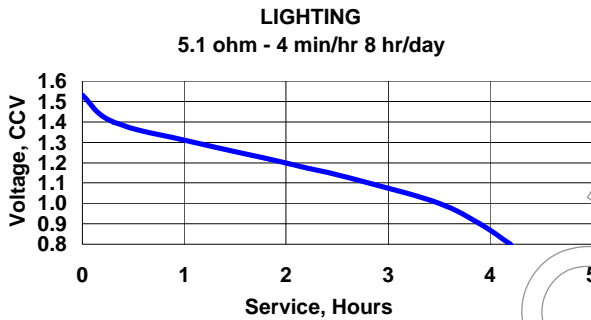

Important Notice

This data sheet contains information specific to batteries manufactured at the time of its publication.

Contents herein do not constitute a warranty.

Copyright © Eveready Battery Co. - All rights reserved