

ENERGIZER NO. EN90

N

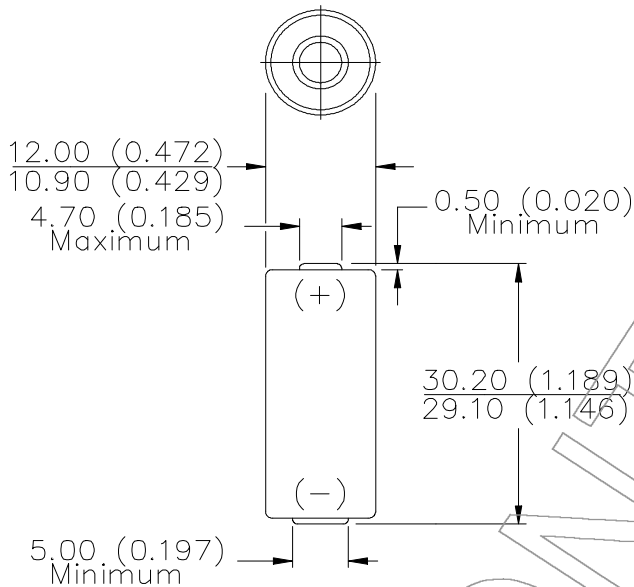

Industry Standard Dimensions in mm (inches)



NOT INTENDED FOR RETAIL TRADE

Chemical System: Alkaline
 Zinc-Manganese Dioxide (Zn/MnO₂)
 (No Added Mercury or Cadmium)

Designation: ANSI-910A, IEC-LR1

Battery Voltage: 1.5 Volts

Operating Temp: -18°C to 55°C (0°F to 130°F)

Average Capacity: 1,000 mAh (to 0.8 volts)
 (Rated capacity at 25 mA continuous drain.)

Average Weight: 9.0 grams (0.3 oz.)

Volume: 3.3 cubic centimeters (0.2 cubic inch)

Cell: One No. 3-0411 (size 'N')

Jacket: Plastic Label

Shelf Life: 7 years (80% of rated capacity)

TEMPERATURE EFFECTS
 Typical Service to 0.8 Volts

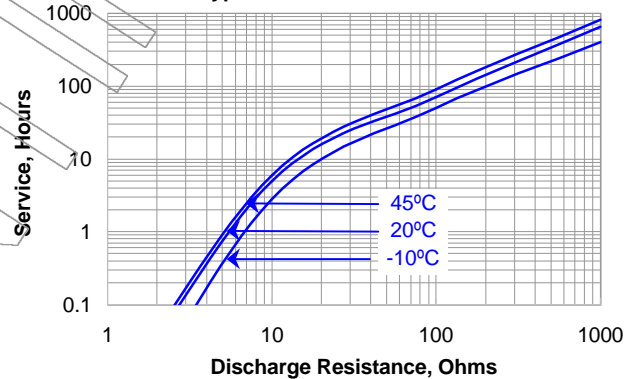

CONSTANT RESISTANCE PERFORMANCE
 Typical Service

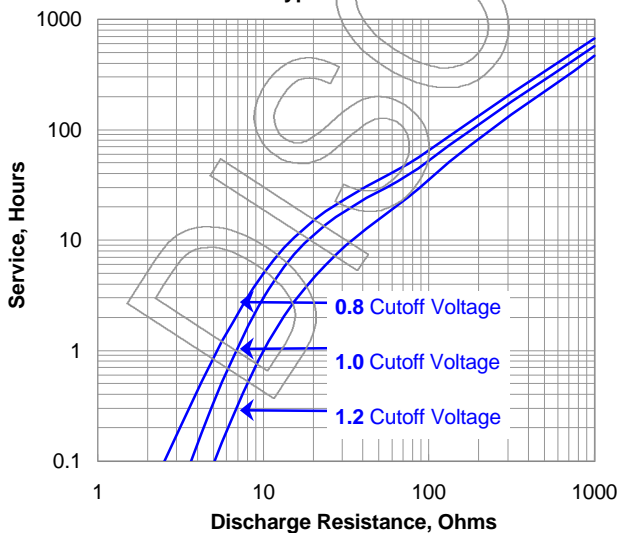

CONSTANT CURRENT DISCHARGE
 Typical Service

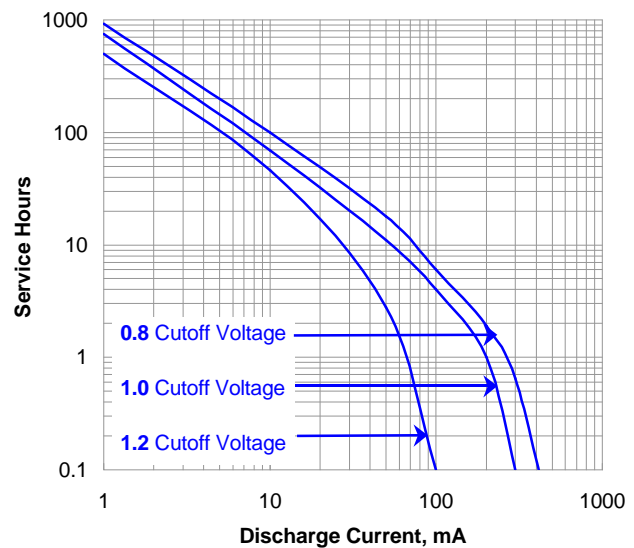

Important Notice

This data sheet contains information specific to batteries manufactured at the time of its publication.

Contents herein do not constitute a warranty.

Copyright © Eveready Battery Co. - All rights reserved

ENERGIZER NO. EN90

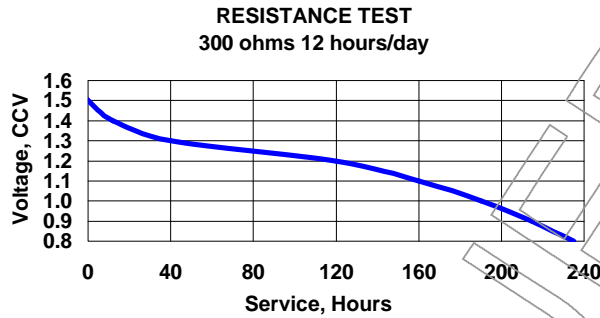

ANSI - IEC Industry Standard Tests @ 20° C

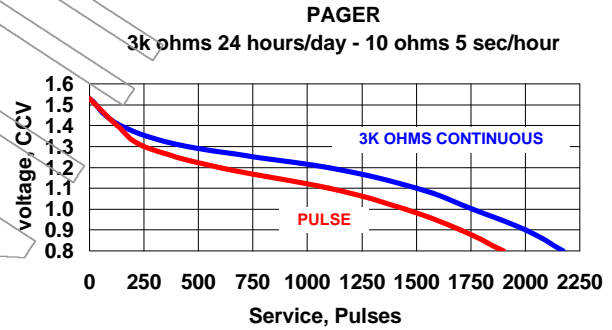
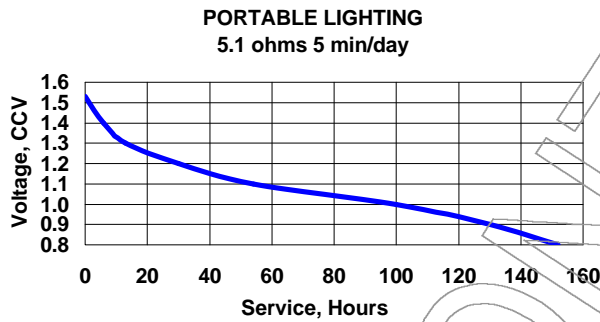

Important Notice

This data sheet contains information specific to batteries manufactured at the time of its publication.

Contents herein do not constitute a warranty.

Copyright © Eveready Battery Co. - All rights reserved