

ENERGIZER EN93

C

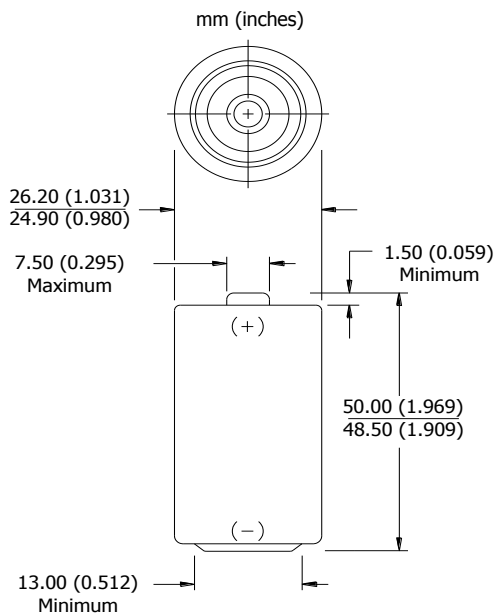

Industry Standard Dimensions



Specifications

NOT INTENDED FOR RETAIL TRADE

- Classification:** Alkaline
- Chemical System:** Zinc-Manganese Dioxide (Zn/MnO₂)
No added mercury or cadmium
- Designation:** ANSI-14A, IEC-LR14
- Nominal Voltage:** 1.5 volts
- Nominal IR:** 150 to 300 milliohms (fresh)
- Operating Temp:** -18°C to 55°C (0°F to 130°F)
- Typical Weight:** 66.2 grams (2.3 oz.)
- Typical Volume:** 26.9 cubic centimeters (1.6 cubic inch)
- Jacket:** Plastic Label
- Shelf Life:** 10 years at 21°C
- Terminal:** Flat Contact

Milliamp-Hours Capacity

Continuous discharge to 0.8 volts at 21°C

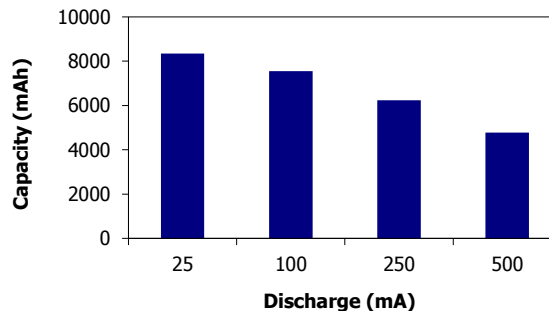

Constant Resistance Performance

Typical Characteristics (21°C)

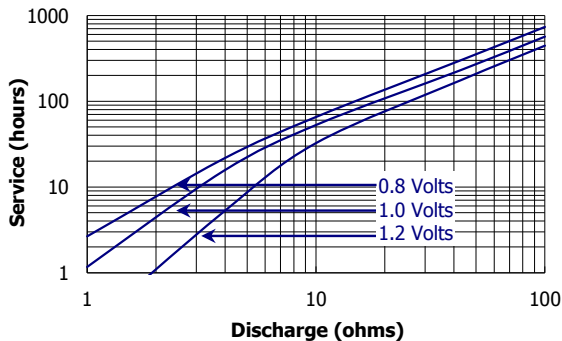

Constant Current Performance

Typical Characteristics (21°C)

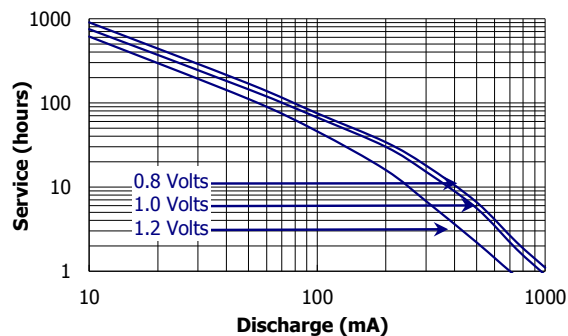

Important Notice

This data sheet contains typical information specific to products manufactured at the time of its publication.
Contents herein do not constitute a warranty and are for reference only.

ENERGIZER EN93



Industry Standard Tests (21°C)

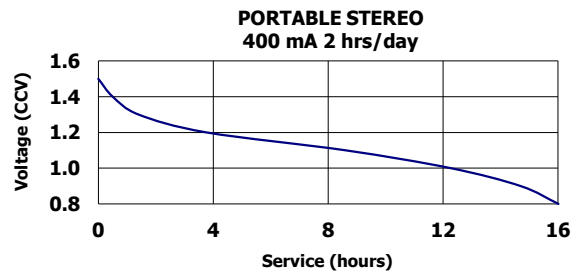
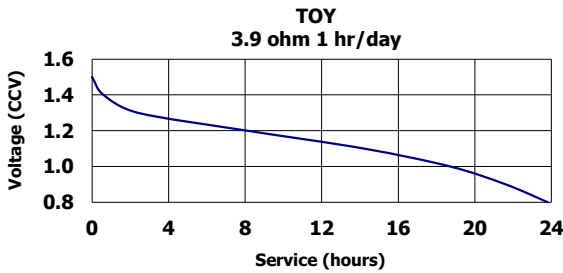
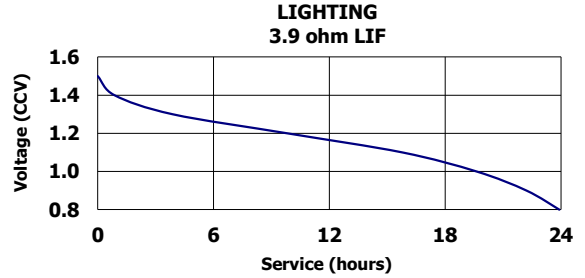
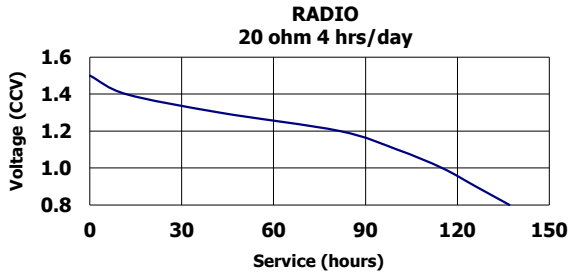

Important Notice

This data sheet contains typical information specific to products manufactured at the time of its publication.
Contents herein do not constitute a warranty and are for reference only.