



## Engineering Data

**C**

**Zinc Chloride 1.5V**  
**Industrial General Purpose**  
 No Added Mercury or Cadmium  
**NOT INTENDED FOR RETAIL TRADE**

### EVEREADY NO. EV35

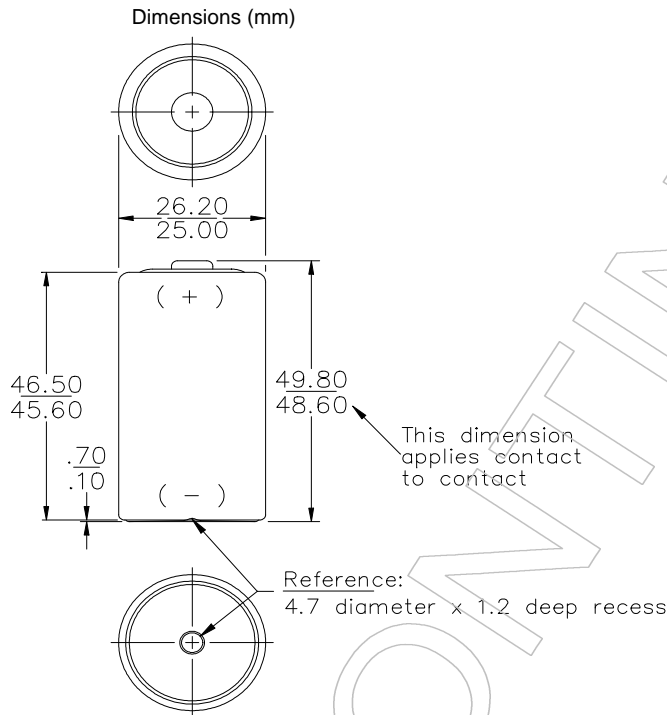

**Chemical System:** Zinc-Manganese Dioxide (Zn/MnO<sub>2</sub>)  
**Designation:** ANSI-14C, IEC-R14  
**Battery Voltage:** 1.5 Volts  
**Average Weight:** 41 grams (1.5 oz.)  
**Volume:** 25.0 cubic centimeters (1.5 cubic inch)  
**Average Service Capacity (to 0.8 Volt / cell):** 2.9 Ah  
 (Rated capacity at 25 mA continuous drain)  
**Cells:** One No. 35 (size "C")  
**Jacket:** Plastic Laminated Paperl

Millimeters	Inches
0.10	0.004
0.70	0.028
1.20	0.047
4.70	0.185
25.00	0.984
26.20	1.031
45.60	1.795
16.50	0.650
48.60	1.913
49.80	1.961

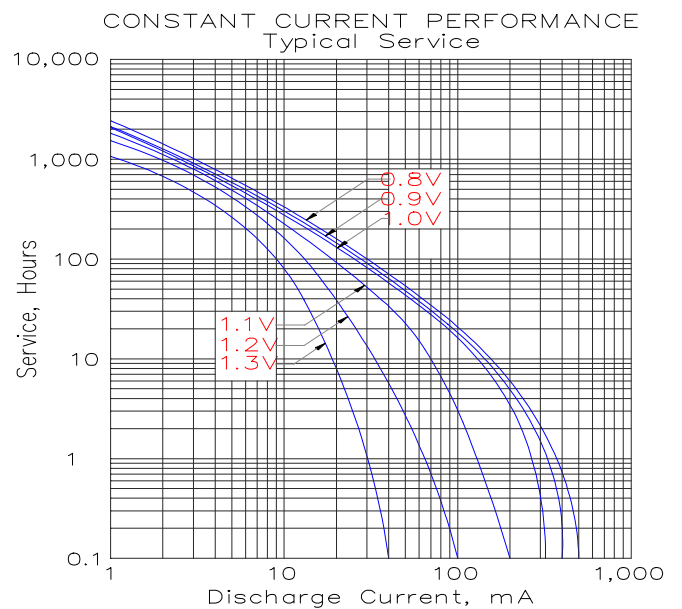
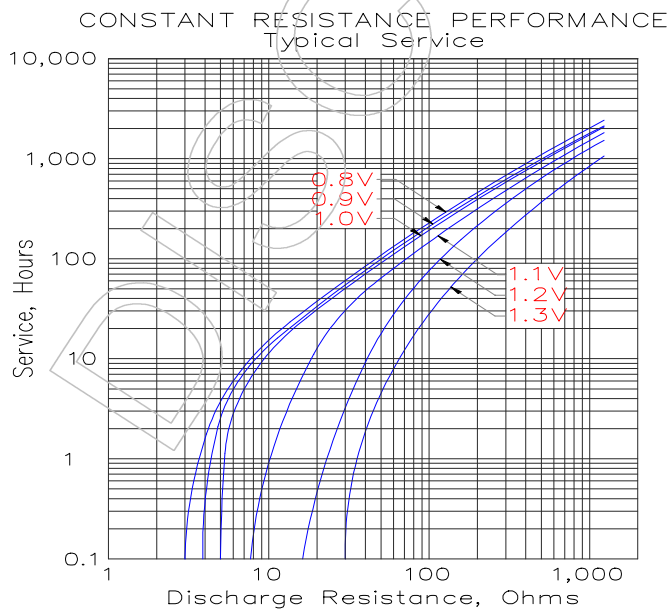

## Typical Applications

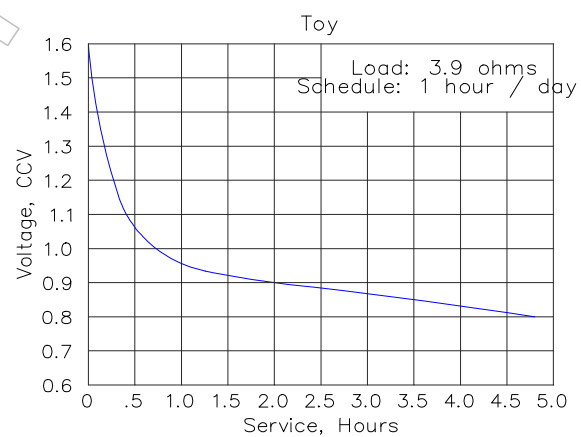
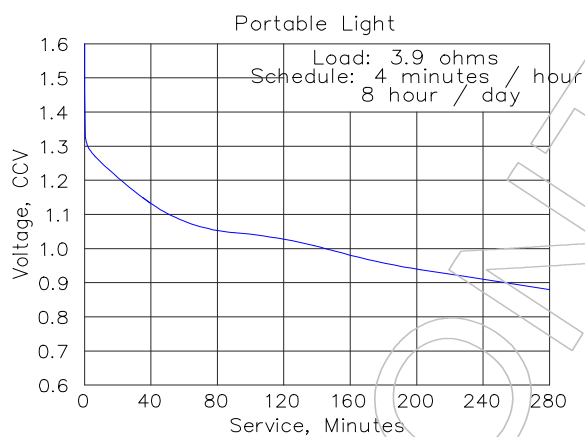
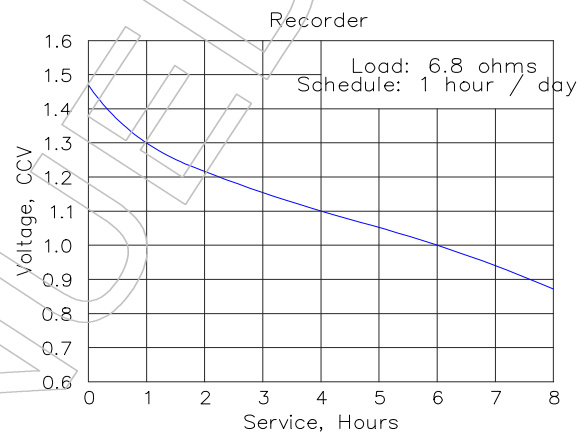
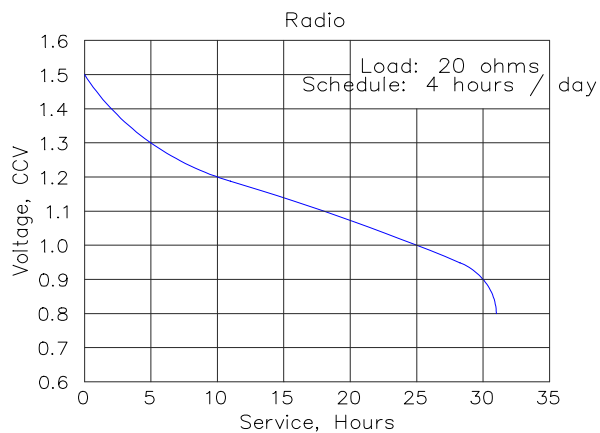

### Important Notice

This data sheet contains information specific to batteries manufactured at time of its publication. Please contact your Energizer representative for most current information. Contents herein do not constitute a warranty.