

**ENERGIZER MAX**

**9V**

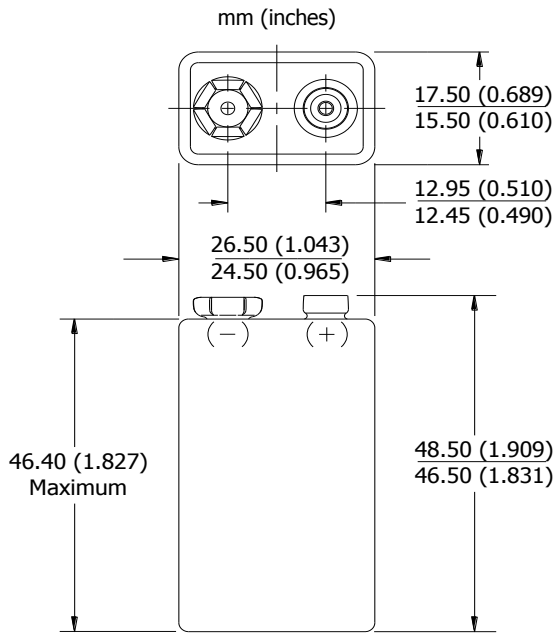

**Industry Standard Dimensions**



**Specifications**

<b>Classification:</b>	Alkaline
<b>Chemical System:</b>	Zinc-Manganese Dioxide (Zn/MnO <sub>2</sub> ) No added mercury or cadmium
<b>Designation:</b>	ANSI-1604A, IEC-6LR61
<b>Nominal Voltage:</b>	9.0 volts
<b>Operating Temp:</b>	-18°C to 55°C (0°F to 130°F)
<b>Typical Weight:</b>	45.6 grams (1.6 oz.)
<b>Typical Volume:</b>	21.1 cubic centimeters (1.3 cubic inch)
<b>Jacket:</b>	Metal
<b>Shelf Life:</b>	5 years at 21°C
<b>Terminal:</b>	Miniature Snap

**Milliamp-Hours Capacity**

Continuous discharge to 4.8 volts at 21°C

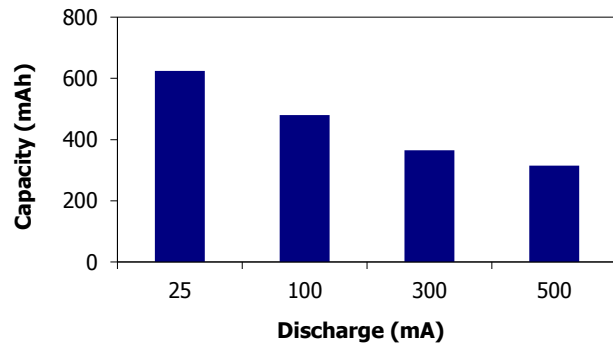

**Device Selection Guide:**

- Toy
- Baby Monitor
- Garage Opener
- Clock Radio
- Smoke Detector

**Battery Selection Indicator**

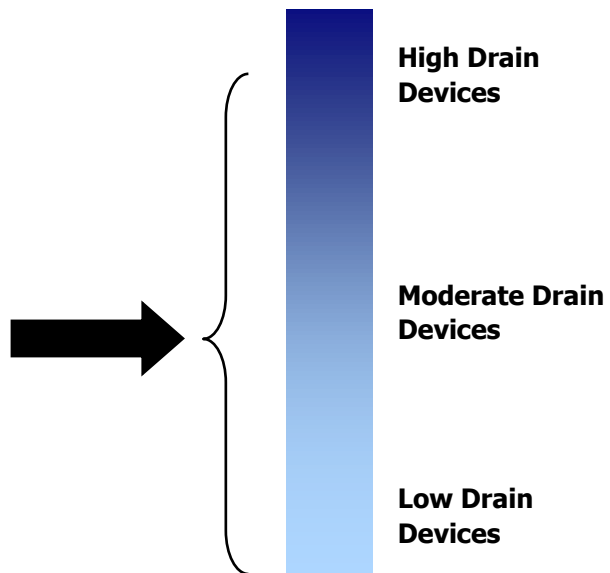

**Important Notice**

This datasheet contains typical information specific to products manufactured at the time of its publication.  
©Energizer Holdings, Inc. - Contents herein do not constitute a warranty.

**ENERGIZER 522**

**9V**

**Constant Resistance Performance**  
Typical Characteristics (21°C)

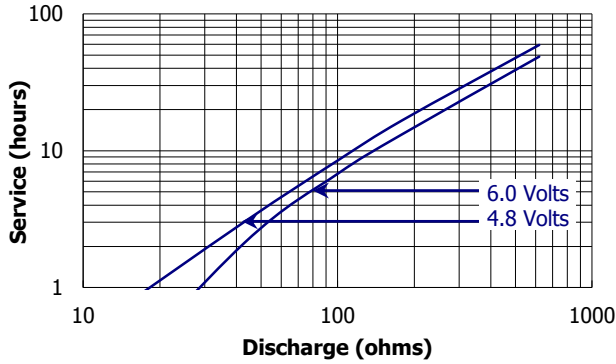

**Constant Current Performance**  
Typical Characteristics (21°C)

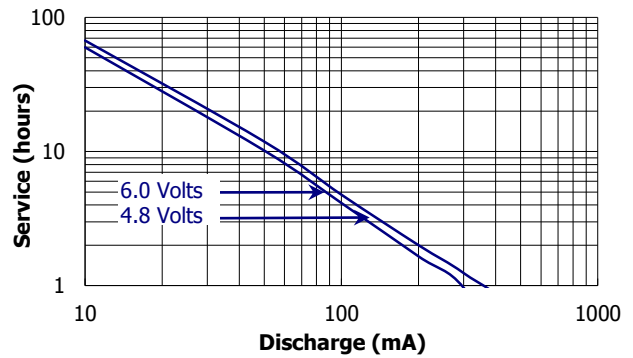

**Industry Standard Tests (21°C)**

**RADIO**  
620 ohm 2 hrs/day

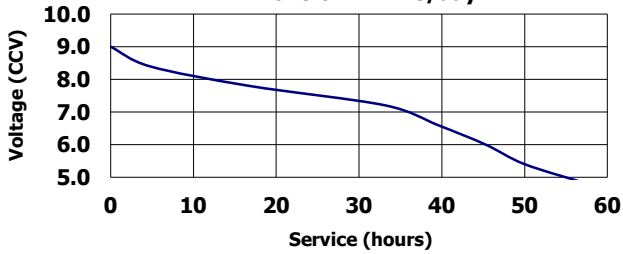

**TOY**  
270 ohm 1 hr/day

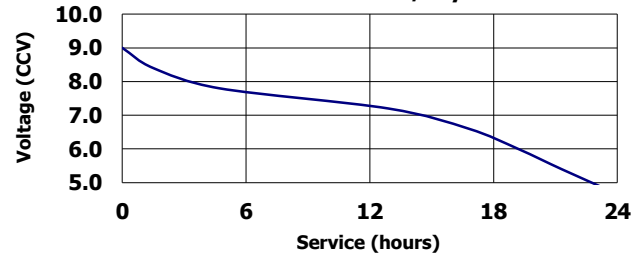

**ACCELERATED SMOKE DETECTOR**  
10K/620 ohm 1 sec/hr pulse

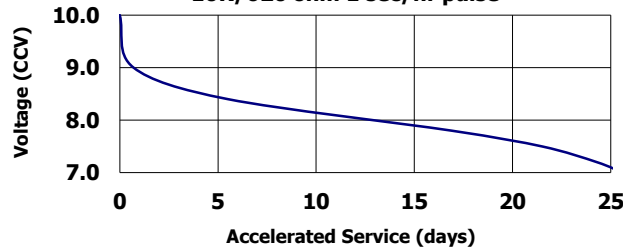

**Important Notice**

This datasheet contains typical information specific to products manufactured at the time of its publication.  
©Energizer Holdings, Inc. - Contents herein do not constitute a warranty.