

ENERGIZER 395/399

ZEROMERCURY

SILVER OXIDE



Industry Standard Dimensions

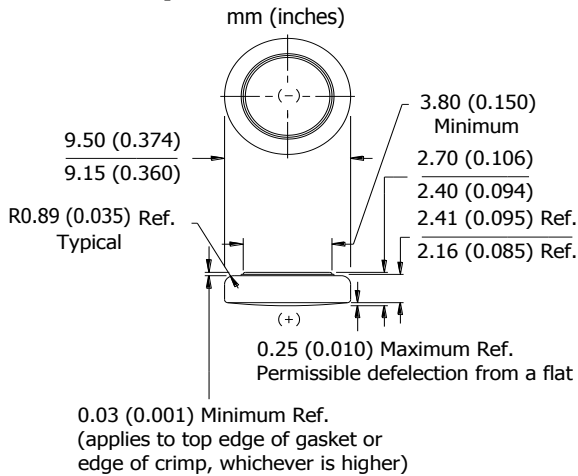

DESIGNED FOR USE ON CONTINUOUS LOW DRAIN
HIGH PULSE ON DEMAND

Specifications

Chemical System:	Silver Oxide (Zn/Ag ₂ O)
Designation:	ANSI-1162SO/1165SO, IEC-SR57
Nominal Voltage:	1.55 Volts
Typical Capacity:	51 mAh* (to 1.2 volts)
Capacity Test:	22K ohm continuous drain at 21°C
Typical Weight:	0.8 grams (0.03 oz.)
Typical Volume:	0.19 cubic centimeters (0.012 cubic inch)
Impedance (40 Hz):	10 to 25 ohms

* Varies according to the applied load, temperature, and cutoff voltage.

Cross Section

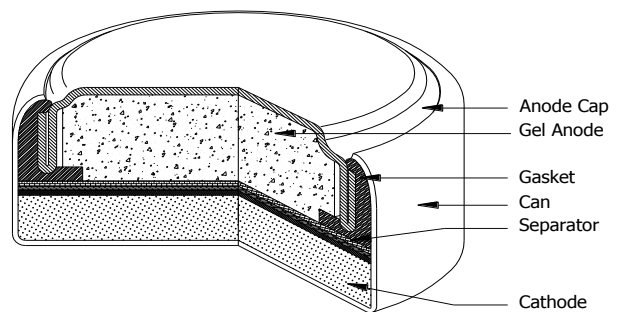

Typical Discharge Characteristics

Typical Performance at 21°C (70°F)

Schedule: Continuous
Typical Drain @1.52V:
0.069 milliamperes
Load: 22K ohm

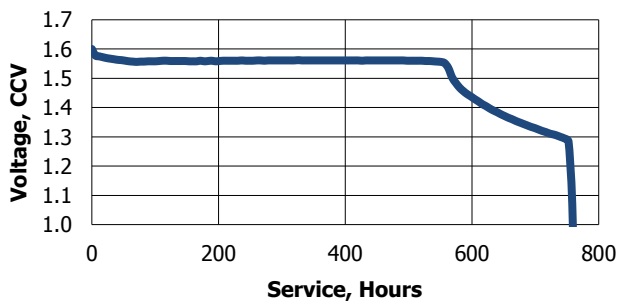

<u>Schedule</u>	<u>Typical Drains</u> at 1.52V (milliamperes)	<u>Load</u> (ohm)	<u>Cutoff</u> 1.2V (hours)
Continuous	0.069	22K	752

Temperature Characteristics

Typical Performance at Low Discharge Rates

Service Effects

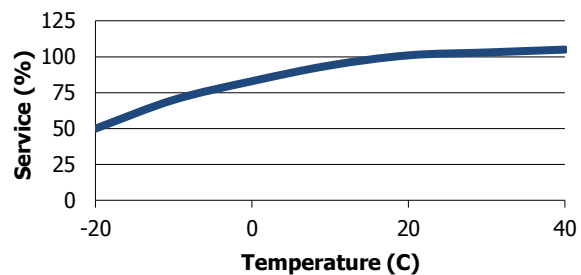

Storage Effects

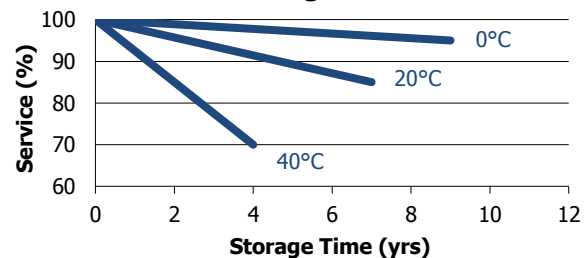

Important Notice

This datasheet contains typical information specific to products manufactured at the time of its publication.
©Energizer Holdings, Inc. - Contents herein do not constitute a warranty.