

**ENERGIZER A93**

**C**



**General Information**

**Classification:** Alkaline  
**Chemical System:** Zinc-Manganese Dioxide (Zn/MnO<sub>2</sub>)  
 No added mercury or cadmium  
**Designation:** ANSI-14A, IEC-LR14  
**Nominal Voltage:** 1.5 volts  
**Operating Temp:** -18°C to 55°C (0°F to 130°F)  
**Typical Weight:** 66 grams  
**Typical Volume:** 27 cubic centimeters  
**Shelf Life:** 10 years at 21°C  
**Terminal:** Flat Contact

**Industry Standard Dimensions**

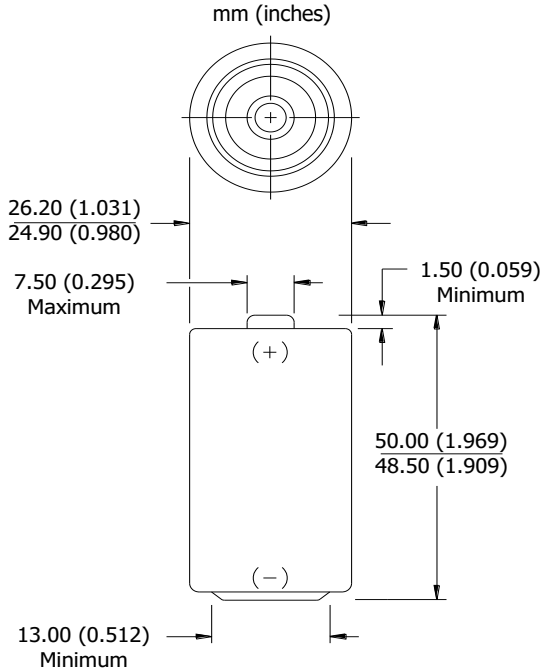



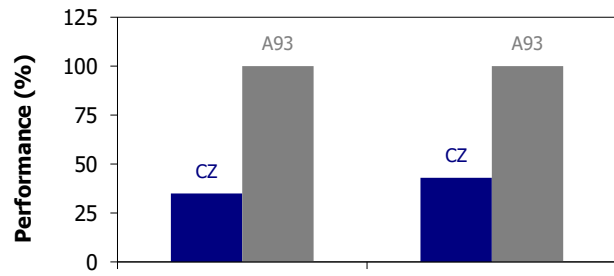

**Performance Comparison**

A93 vs. Typical Carbon Zinc (C) at 21°C



Industry Standard Testing Protocol

**Device Selection Guide:**

- Portable Stereo 
- Toy 
- Lighting 
- Radio 

**Battery Selection Indicator**

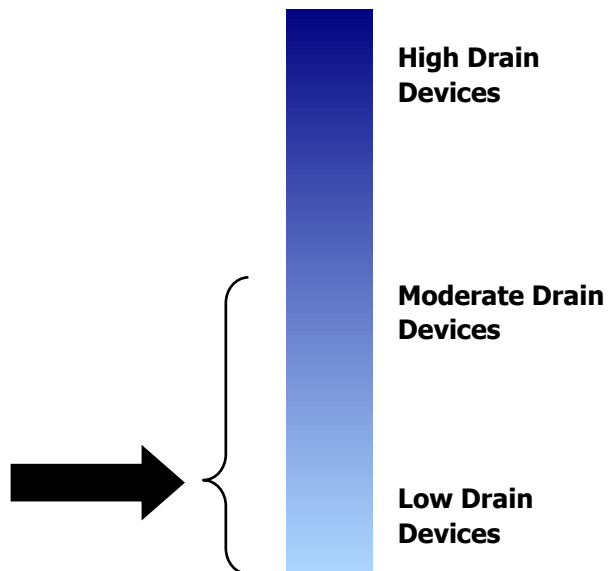

**Important Notice**

This datasheet contains typical information specific to products manufactured at the time of its publication.  
**Contents herein do not constitute a warranty and are for reference only.**