

ENERGIZER LR6

ALKALINE POWER

AA



Industry Standard Dimensions

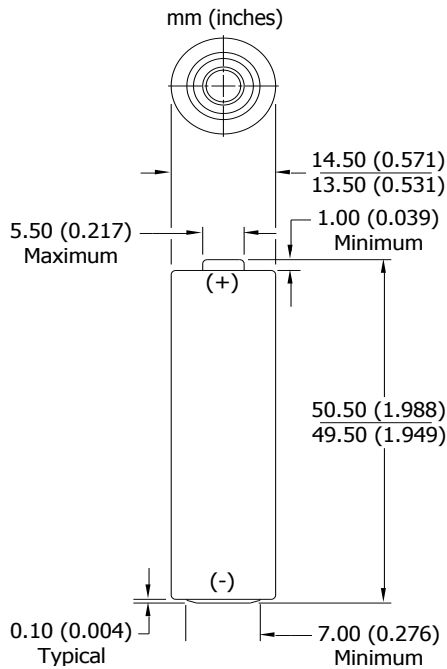

Specifications

Classification:	Alkaline
Chemical System:	Zinc-Manganese Dioxide (Zn/MnO ₂) No added mercury or cadmium
Designation:	IEC-LR6
Nominal Voltage:	1.5 volts
Nominal IR:	150 to 300 milliohms (fresh)
Operating Temp:	-18°C to 55°C
Typical Weight:	23.0 grams
Typical Volume:	8.1 cubic centimeters
Jacket:	Plastic Label
Shelf Life:	10 years at 21°C
Terminal:	Flat Contact

Milliamp-Hours Capacity

Continuous discharge to 0.8 volts at 21°C

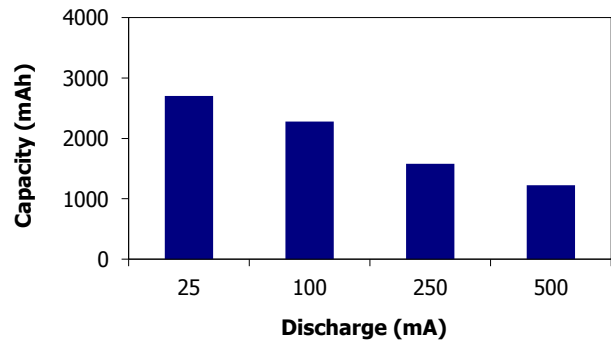

Constant Power Performance

Typical Characteristics (21°C) to 0.8 Volts

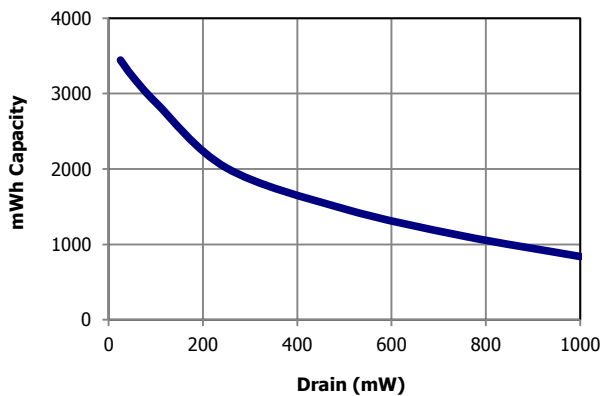

Constant Current Performance

Typical Characteristics (21°C) to 0.8 Volts

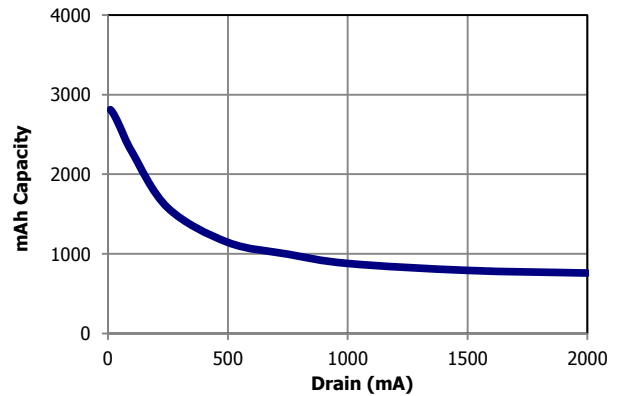

Important Notice

This data sheet contains typical information specific to products manufactured at the time of its publication. Physical values are for reference purposes and not intended for specific calculations.

©Energizer Brands, LLC - Contents herein do not constitute a warranty.

ENERGIZER E91



Constant Power Performance
Typical Characteristics (21°C)

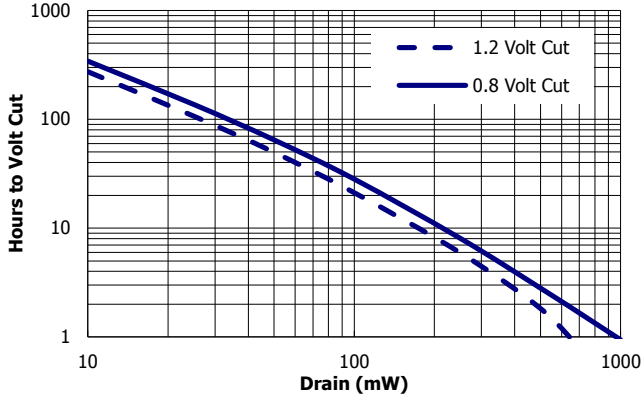

Constant Current Performance
Typical Characteristics (21°C)

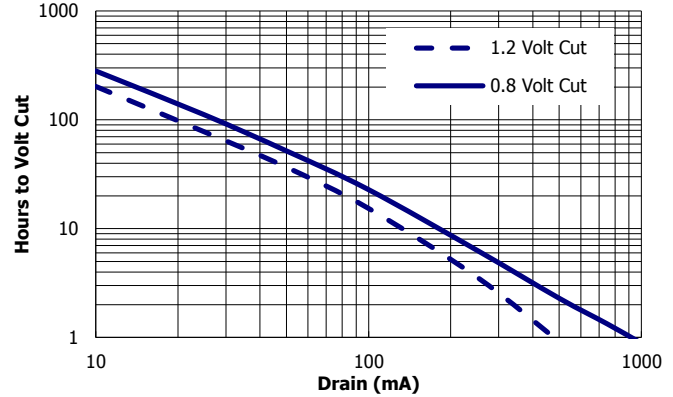

Industry Standard Tests (21°C)

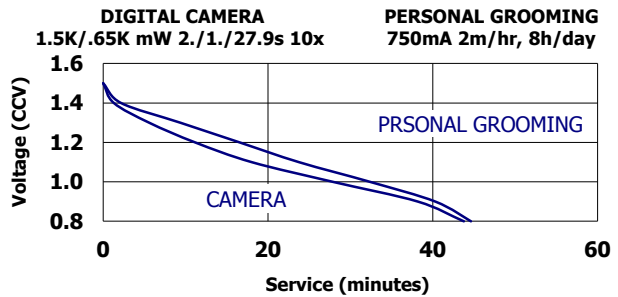
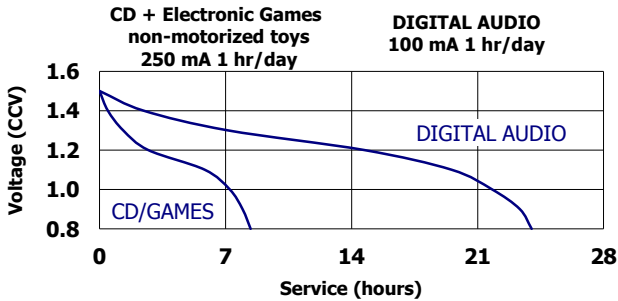
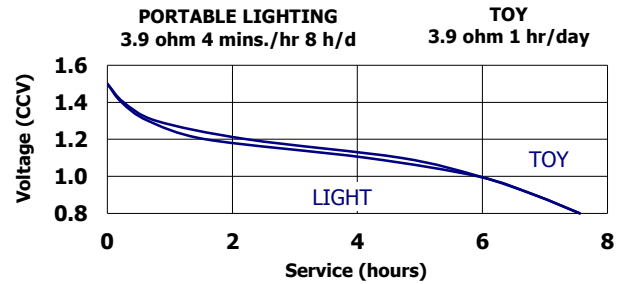
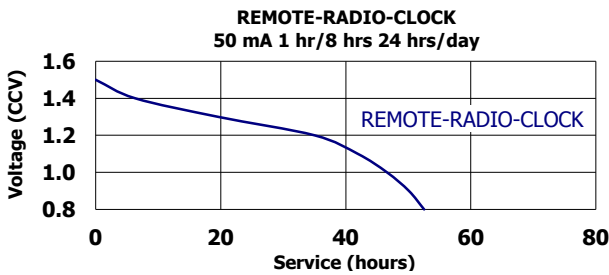

Important Notice

This data sheet contains typical information specific to products manufactured at the time of its publication. Physical values are for reference purposes and not intended for specific calculations.
©Energizer Brands, LLC - Contents herein do not constitute a warranty.